



## TP-S-755H

### VIVE Comfort

1111 S. Glenstone Ave., Suite 2-100  
Springfield, MO 65804

**Toll-Free:** 1-800-776-1635 **Web:** [www.vivecomfort.com](http://www.vivecomfort.com)  
**Hours of Operation:** M-F 9AM - 6PM Eastern

### Thermostat Applications Guide

Description	
Gas or Oil Heat	Yes
Electric Furnace	Yes
Heat Pump (No Aux. or Emergency Heat)	Yes
Heat Pump (with Aux. or Emergency Heat)	Yes
Multi-stage Systems	Yes
Heat Only Systems	Yes
Cool Only Systems	Yes
Millivolt	Yes
Any HVAC System up to 3H/2C with standard low voltage controlled humidifier.	Yes
Any HVAC System up to 3H/2C with standard low voltage controlled de-humidifier.	Yes

### Table of Contents

### Page

Installation Tips	2
Thermostat Quick Reference	3
Subbase Installation	4
Wiring	5-6
Technician Setup Menu	7-11
Setting the Humidity	12
Mounting and Battery Installation	13
Programming the Thermostat	14-15
Specifications	16

### Power Type

Battery Power  
Hardwire (Common Wire)  
Hardwire (Common Wire) with Battery Backup

**A trained, experienced technician must install this product.**

Carefully read these instructions. You could damage this product or cause a hazardous condition if you fail to follow these instructions.

Una versión en español de este manual se puede descargar en la página web de la compañía.

## Wall locations

The thermostat should be installed approximately 4 to 5 feet above the floor. Select an area with average temperature and good air circulation.

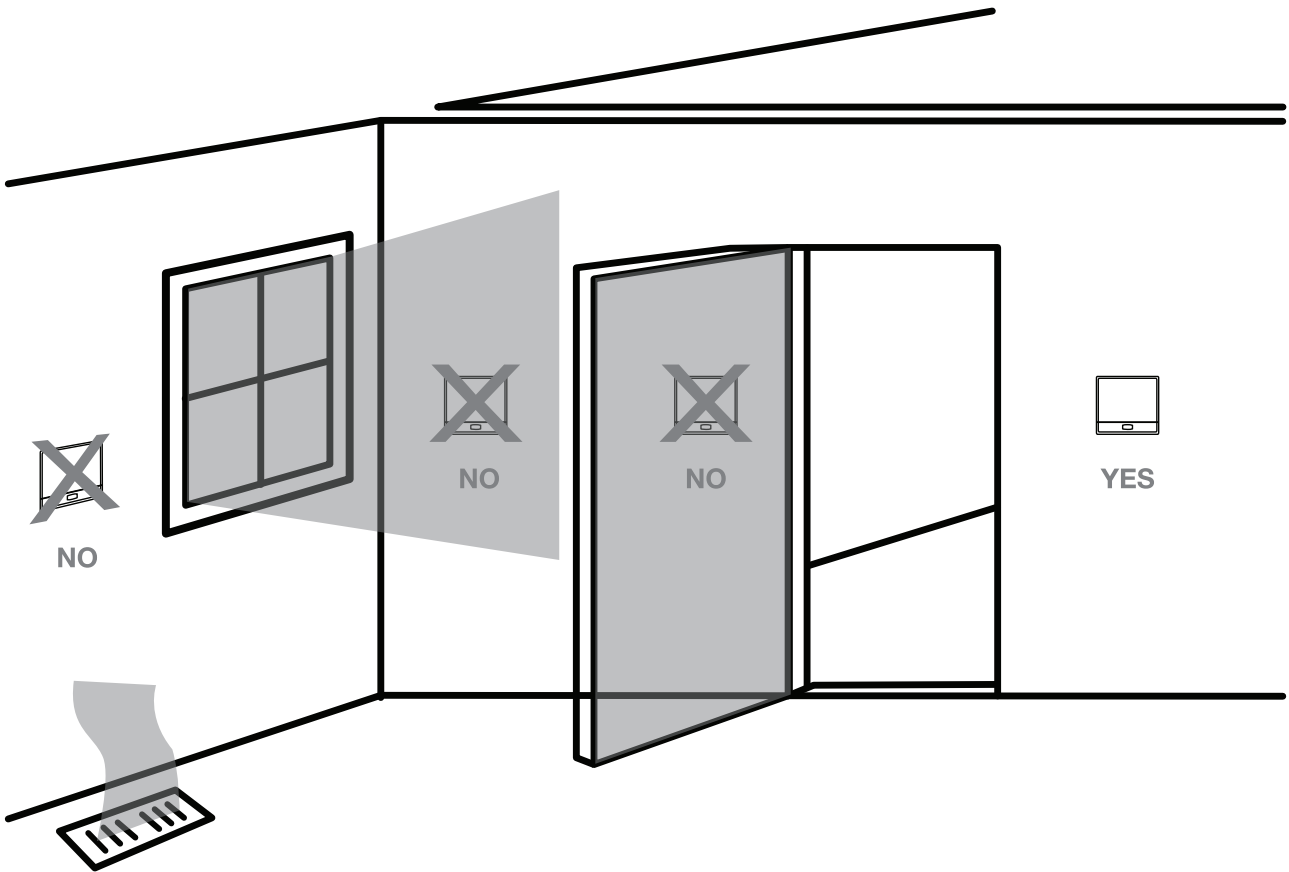

**Do not install** thermostat in locations:

- Close to hot or cold air ducts
- That are in direct sunlight
- With an outside wall behind the thermostat
- In areas that do not require conditioning
- Where there are dead spots or drafts (in corners or behind doors)
- Where there might be concealed chimneys or pipes
- Where appliances could radiate heat

## Installation Tip

Pick an installation location that is easy for the user to access. The temperature of the location should be representative of the building.

## Getting to know your thermostat



- ② **Glow in the Dark Light Button**
- ③ **Fan Button**
- ④ **System Button**
- ⑤ **User Program Buttons**
- ⑥ **Temperature Setpoint Buttons**
- ⑦ **Battery Door**
- ⑧ **Universal Private Label Badge**

### ① LCD

Days of the week and time

Displays the user selectable setpoint temperature.

**HOLD** is displayed when thermostat program is permanently overridden.

**Menu Options:** Shows different options

**Low Battery Indicator:** Replace batteries when this indicator is shown.

**Programmable Time Period Icons:** This thermostat has 4 programmable time periods per day.

**System:** Selects heat, off or cool as needed.

+1 will appear in the display when second stage of heat or cool is on. +2 will appear for third stage of heat.

Indicates the current room temperature.

**COOL HEAT FAN**

The **COOL, HEAT** or **FAN** icon will display when the **COOL, HEAT** or **FAN** is on. NOTE: The compressor delay feature is active if these icons are flashing. The compressor will not turn on until the 5 minute delay has elapsed.



### Important:

The low battery indicator is displayed when the AA battery power is low. If the user fails to replace the battery within 21 days, the thermostat display will only show the low battery indicator as a final warning before the thermostat becomes inoperable. The batteries are located on the front of the thermostat.

## Removing the private label badge



Use the bevel on lower ridge

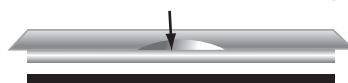

Magnet in door

Gently slide a screwdriver into the bottom edge of the badge. Gently turn the screwdriver counter clockwise. The badge is held on by a magnet. The badge should pry off easily. **Do not use force.**

## About the Badge

All our thermostats use the same universal magnetic badge. Visit our website to learn more about our dealer imprinting programs.



**Caution:  
Electrical Hazard**

Failure to disconnect the power before beginning to install this product can cause electrical shock or equipment damage.



**Mercury Notice:**

All of our products are mercury free. However, if the product you are replacing contains mercury, dispose of it properly. Your local waste management authority can give you instructions on recycling and proper disposal.

For vertical mount put one screw top and one screw bottom.

For horizontal mount put one screw left and one screw right.

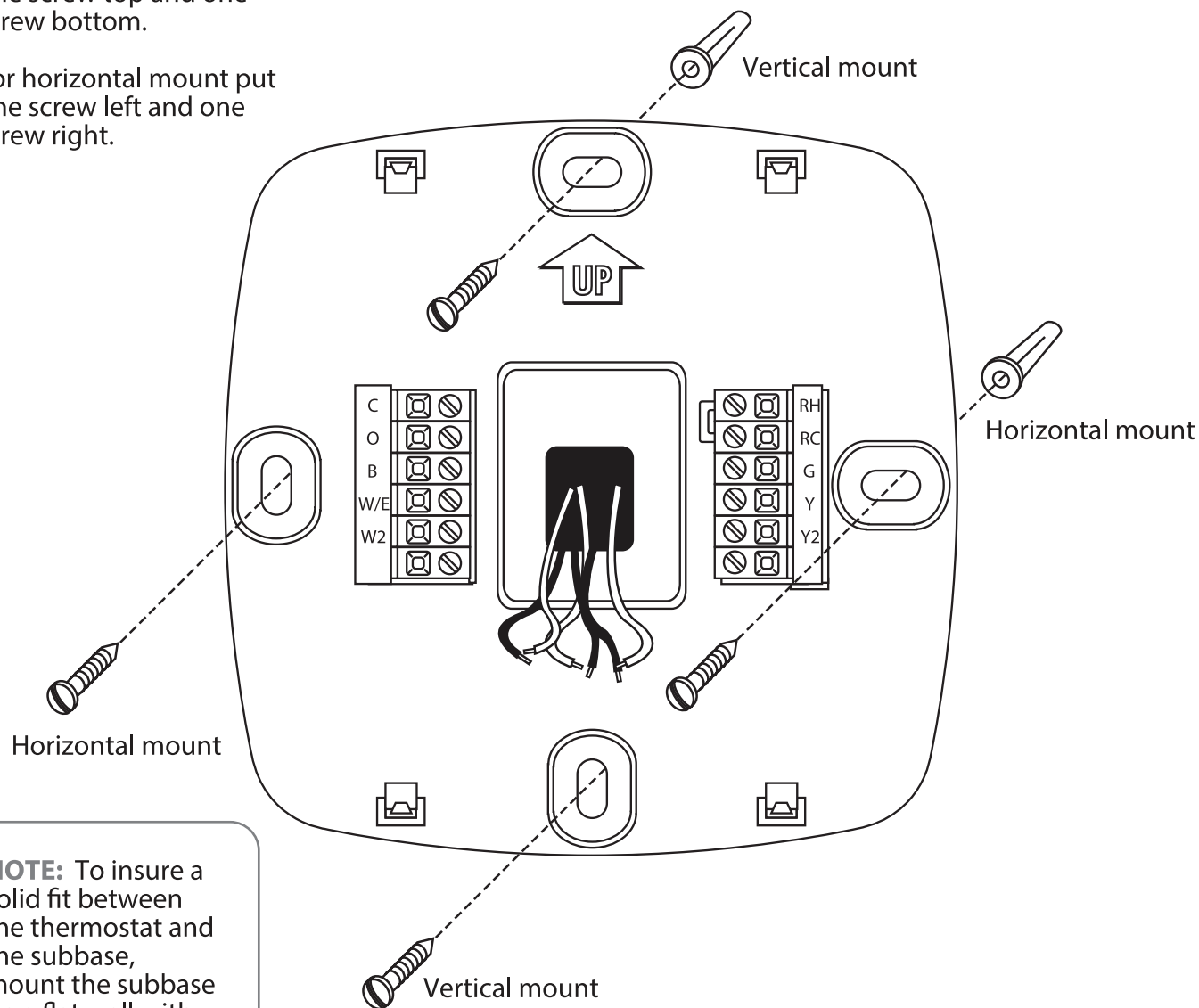

**NOTE:** To insure a solid fit between the thermostat and the subbase, mount the subbase on a flat wall with the drywall anchors flush to the wall.



## Wiring

1. If you are replacing a thermostat, make note of the terminal connections on the thermostat that is being replaced. In some cases the wiring connections will not be color coded. For example, the green wire may not be connected to the **G** terminal.
2. Loosen the terminal block screws. Insert wires then retighten terminal block screws.
3. Place nonflammable insulation into wall opening to prevent drafts.
4. Push wire into the wall so the thermostat can mount securely to the subbase.



### Warning:

All components of the control system and the thermostat installation must conform to Class II circuits per the NEC Code.

### Wire Specifications

Use shielded or non-shielded 18 - 22 gauge thermostat wire.

## Terminal Designations

This thermostat is shipped from the factory to operate a conventional heating and cooling system. This thermostat will also operate a heat pump system. See the "heat pump" configuration step on page 8 of this manual to configure the thermostat for heat pump applications.

Terminal	2 Heat 2 Cool Conventional System	2 Heat 2 Cool Heat Pump System	3 Heat 2 Cool Heat Pump System
RC	Transformer power (cooling)	Transformer power (cooling)	Transformer power (cooling)
RH	Transformer power (heating)	Transformer power (heating)	Transformer power (heating)
C	Transformer common (For 2 transformer systems, use RH common.)	Transformer common	Transformer common
B	Energized in heating	Heat pump changeover valve energized in heating	Heat pump changeover valve energized in heating
O	Energized in cooling	Heat pump changeover valve energized in cooling	Heat pump changeover valve energized in cooling
G	Fan relay	Fan relay	Fan relay
W/E	First stage of heat	Emergency heat relay	Emergency heat relay
W2	Second stage of heat	Auxiliary heat relay, second stage of heat	Auxiliary heat relay, third stage of heat
Y	First stage of cool	First stage of heat & cool	First stage of heat & cool
Y2	Second stage of cool	Second stage of cool	Second stage of cool & second stage of heat
H	Humidify	Humidify	Humidify
D	Dehumidify	Dehumidify	Dehumidify

### Wiring Tips:

#### C terminal

The **C** (common wire) terminal does not have to be connected when the thermostat is powered by batteries.

#### Note:

In many systems with no emergency heat relay a jumper can be installed between E and W2.

- ▲ 1 Power supply.
- ▲ 2 Factory-installed jumper. Remove only when installing on 2-transformer systems.
- ▲ 3 Use either O or B terminals for changover valve.
- ▲ 4 Optional 24 VAC common connection when thermostat is used in battery power mode.
- ▲ 5 If DEHUM Relay requires a normally-energized input, set Dehumidity Relay to NC in Technician Setup.

**Typical 2H/2C system: 1 transformer**

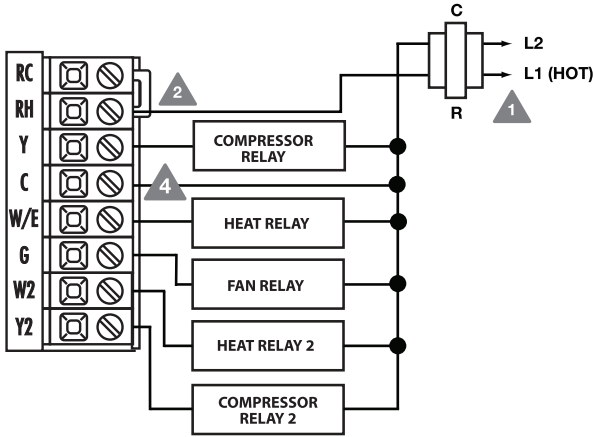

**Typical 2H/2C system: 2 transformer**

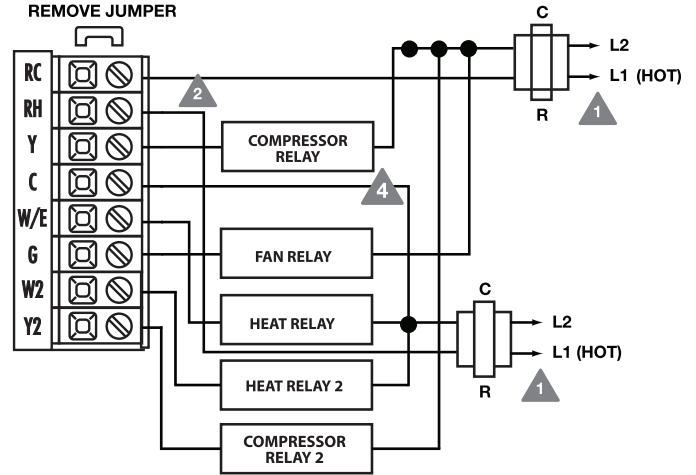

**Typical 3H/2C heat pump system**

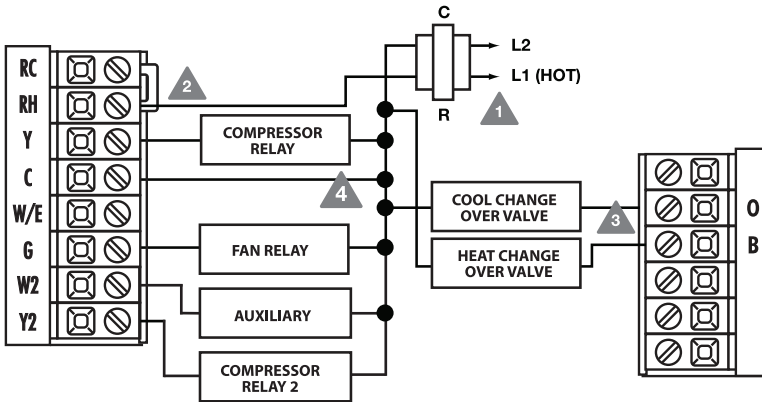

**Typical 2H/2C system with 24VAC Humidifier**

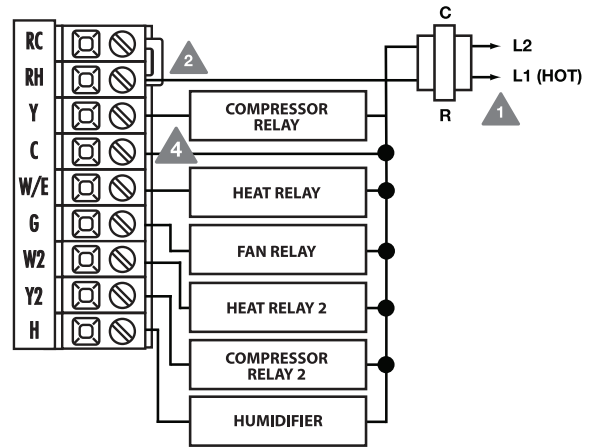

**Typical 2H/2C system with Dehum Terminal**

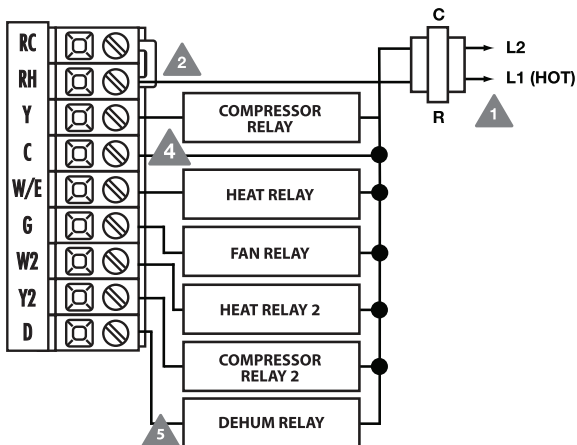

**Typical 2H/2C system with Dry Contact Humidifier**

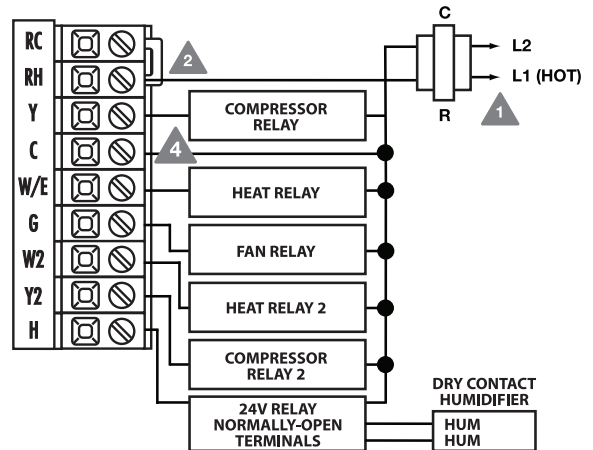



**NOTE:** In many systems with no emergency heat relay a jumper can be installed between E and W2.

### Technician Setup Menu

This thermostat has a technician setup menu for easy installer configuration. To set up the thermostat for your particular application:

1. Press **MENU** button
2. Press and hold **TECH SETUP** button for 3 seconds. This 3 second delay is designed so that homeowners do not accidentally access the installer settings.

3. Configure the installer options as desired using the table below.

Use the  or  keys to change settings and the **NEXT STEP** or **PREV STEP** key to move from one option to another. **Note:** Only press **DONE** key when you want to exit the Technician Setup options.

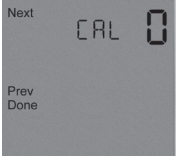
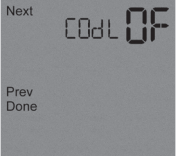
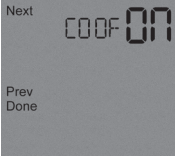
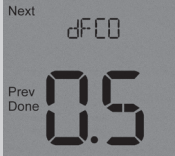
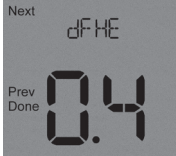
Tech Setup Steps					
Filter Change Reminder	Room Temperature Calibration	Minimum Compressor On Time	Compressor Short Cycle Delay	Cooling Swing	Heating Swing
This feature will flash <b>FILT</b> in the display after the elapsed run time to remind the user to change the filter. A setting of <b>OFF</b> will disable this feature.	This feature allows the installer to change the calibration of the room temperature display. For example, if the thermostat reads 70° and you would like it to read 72° then select +2.	This feature allows the installer to select the minimum run time for the compressor. For example, a setting of 4 will force the compressor to run for at least 4 minutes every time the compressor turns on, regardless of the room temperature.	The compressor short cycle delay protects the compressor from "short cycling". This feature will not allow the compressor to be turned on for 5 minutes after it was last turned off.	The swing setting, often called "cycle rate", "differential" or "anticipation" is adjustable. A smaller swing setting will cause more frequent cycles and a larger swing setting will cause fewer cycles.	The swing setting, often called "cycle rate", "differential" or "anticipation" is adjustable. A smaller swing setting will cause more frequent cycles and a larger swing setting will cause fewer cycles.
LCD Will Show					
					
Adjustment Options					
You can adjust the filter change reminder from <b>OFF</b> to 2000 hours of runtime in 50 hour increments.	You can adjust the room temperature display to read -4°F to +4°F above or below the factory calibrated reading.	You can select the minimum compressor run time from "off", "3", "4", or "5" minutes. If 3, 4, or 5 is selected, the compressor will run for at least the selected time before turning off.	Selecting <b>ON</b> will not allow the compressor to be turned on for 5 minutes after the last time the compressor was on. Select <b>OFF</b> to remove this delay.	The cooling swing setting is adjustable from ±0.2°F to ±2°F. For example: A swing setting of 0.5°F will turn the cooling on at approximately 0.5°F above the setpoint and turn the cooling off at approximately 0.5°F below the setpoint.	The heating swing setting is adjustable from ±0.2°F to ±2°F. For example: A swing setting of 0.5°F will turn the heating on at approximately 0.5°F below the setpoint and turn the heating off at approximately 0.5°F above the setpoint.
Factory Default Settings					
OFF	0°F	OFF	ON	0.5°F	0.4°F

TECH SETUP  
STEPS CONTINUED  
ON THE NEXT PAGE







## Tech Setup Steps (Continued from the previous page)

Heating Temperature Setpoint Limit	Cooling Temperature Setpoint Limit	Morning Recovery	°F or °C	12 or 24 Hour Clock	Fan Operation	Program Options
This feature allows you to set a maximum heat setpoint value. The setpoint temperature cannot be raised above this value.	This feature allows you to set a minimum cool setpoint value. The setpoint temperature cannot be lowered below this value.	This feature turns your system on before the WAKE programming time to ensure the environment is at the WAKE setpoint when the WAKE time period begins. This recovery changes over time based on the previous days experience.	Select F for Fahrenheit temperature read out or select C for Celsius read out	You can select either a 12 or 24 hour clock setting.	Select GAS for systems that control the fan during a call for heat.  Select ELEC to have the thermostat control the fan during a call for heat.	You can configure this thermostat to have a 5+1+1 program or non-programmable.
LCD Will Show						
Adjustment Options						
Use the <b>+</b> or <b>-</b> key to select the maximum cool setpoint.	Use the <b>+</b> or <b>-</b> key to select the minimum cool setpoint.	Use the <b>+</b> or <b>-</b> key to turn on or off.	°F for Fahrenheit °C for Celsius	Use the <b>+</b> or <b>-</b> key to select 12 or 24 hour clock.	GA or EL	Use the <b>+</b> or <b>-</b> key 5d for 5+1+1, or 0d for non-programmable.
Factory Default Settings						
90	44	ON	°F	12 Hour Clock	GAS	5d

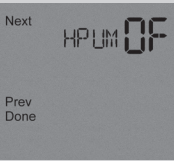
## Swing Setting Tip

The second stage will turn on at 2x the swing setting. The second stage will turn off when 1x the swing is reached. For example, if the swing setting is .8 degrees for heating and the thermostat is set at 70°F, the first stage will turn on at approximately 69.2°F. The second stage will turn on at 68.4°F. The second stage will turn off at 69.2°F and the first will turn off at 70.8°F. If third stage is used, it will turn on at 3x the swing and turn off at approximately 2x the swing.

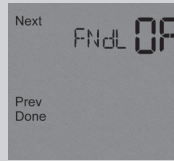
Tech Setup Steps (Continued from the previous page)				
Heat Pump	System Switch	Gas Auxiliary for Heat Pump	Stages of Heat	Cooling Fan Delay
<p>When turned on the thermostat will operate a heat pump.</p> <p>1. EM.Heat will show as an option in the system switch.</p> <p>2. Y will be first stage of heat &amp; cool, W/E will be emergency heat relay &amp; W2 will be auxiliary heat relay.</p>	<p>You can configure the system switch for the particular application:</p> <p>Heat - Off - Cool, Heat - Off, Cool - Off,</p> <p>Note: EM. Heat will show if in heat pump mode.</p>	<p>This option will turn the heat pump off 45 seconds after the auxiliary heat relay turns on.</p> <p>For 2 heat applications, the first stage will turn off 45 seconds after the auxiliary stage turns on.</p> <p>For 3 heat applications, the first and second stage will turn off 45 seconds after the auxiliary stage turns on.</p>	<p>You can configure the thermostat to operate a 3 stage heat pump system.</p> <p>2H = 2 heat, 2 cool 3H = 3 heat, 2 cool</p>	<p>The cooling fan delay setting will delay the fan from coming on in cool mode and keep running after the compressor shuts off for a short time to save energy in some systems.</p>
LCD Will Show				
				
Adjustment Options				
<p>OFF configures the thermostat for non heat pump systems</p> <p>ON configures the thermostat for heat pump systems</p>	<p>Use the <b>+</b> or <b>-</b> key until the desired application is flashing.</p>	<p>For heat pump systems that are "dual fuel" (uses a gas furnace for auxiliary stage heat) you can turn this feature on to turn off the heat pump when the auxiliary stage of heating has been called for.</p>	<p>Use the <b>+</b> or <b>-</b> key to change between 2 heat and 3 heat.</p> <p>2 heat will use Y1 as first stage and W2 as auxiliary.</p> <p>3 heat will use Y1 as first stage, Y2 as second stage and W2 as auxiliary.</p>	<p>You can select the Cooling Fan Delay from "Off", "15", "30", "60" or "90" seconds. If 15, 30, 60 or 90 is selected the fan will not turn on for that many seconds when there is a call for cool and will run for that many seconds after satisfying a call for cool.</p>
Factory Default Settings				
OFF	Heat - Off - Cool	OFF	2 Stages	OFF

TECH SETUP  
STEPS CONTINUED  
ON THE NEXT PAGE

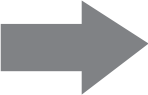

## Tech Setup Steps (Continued from the previous page)

Humidify	Dehumidify	Humidity Calibration	Dehumidify with AC	Over Cool Limit	HUM Terminal	DHM Terminal
This feature adds humidity when System key is in Heat .	This feature removes humidity when System key is in Cool .	This feature allows the installer to change the calibration of the ambient humidity displayed.	This feature forces the A/C to run longer to remove humidity when needed. The A/C will “over cool” the room a few degrees until the humidity reaches the desired setpoint.	The amount of over cooling allowed when using A/C to remove humidity. This screen is only shown when ON is selected in the “Dehumidify with AC” tech setup step.	Options for how the Hum terminal energizes.	Option for how the DHM terminal energizes.
LCD Will Show						
Adjustment Options						
Use the <b>+</b> or <b>-</b> key to turn on or off. If ON is selected the humidity will be displayed on the main screen and HUM terminal will energize when humidity setpoint is above ambient humidity in Heat mode.	Use the <b>+</b> or <b>-</b> key to turn on or off. If ON is selected the humidity will be displayed on the main screen and DHM terminal will energize when humidity setpoint is below ambient humidity in Cool mode.	Use the <b>+</b> or <b>-</b> key to adjust the calibration +/- 3.	Use the <b>+</b> or <b>-</b> key to select YES or NO . If selected YES allows over cooling to be used to control humidity in Cool mode. If NO is selected the system will not use over cooling.	Use the <b>+</b> or <b>-</b> key to select the maximum number of degrees of over cool. Options are: 2, 3, 4, 5	Use the <b>+</b> or <b>-</b> key to select one of the four options. View the HUM Terminal chart below for an explanation of these options.	Use the <b>+</b> or <b>-</b> key to select one of the four options. View the DHM Terminal chart below for an explanation of these options.
Factory Default Settings						
OFF	OFF	0	NO	3	1	1

### HUM Terminal

OPTIONS	HUM terminal energizes when the ambient humidity is...
1	below the humidity setpoint and heat or fan is energized.
2	below the humidity setpoint and heat is energized.
3	below the humidity setpoint. It will also energize the fan during a call for humidity.
4	below the humidity setpoint.

### DHM Terminal

OPTIONS	DHM terminal energizes when the ambient humidity is...
1	above the humidity setpoint and cool or fan is energized.
2	above the humidity setpoint. It will also energize the fan during a call for humidity.
3	above the humidity setpoint.
4	above the humidity setpoint and the compressor is not running.

TECH SETUP  
STEPS CONTINUED  
ON THE NEXT PAGE



Tech Setup Steps (Continued from the previous page)		
Dehumidify Relay	Satisfy Setpoint	Staging Delay
<p>You can configure the D terminal as Normally-Open or Normally-Closed.</p> <p>NO = Normally-Open</p> <p>NC = Normally-Closed</p>	<p>This feature allows the thermostat to keep multiple stages of heat or cool energized until setpoint is satisfied.</p>	<p>This feature allows a delay to occur when a second and third stage is needed. This allows the previous stage extra time to satisfy setpoint.</p>
LCD Will Show		
Adjustment Options		
<p>Use the <b>+</b> or <b>-</b> key to select NO or NC.</p> <p>If NO is selected, D will energize to dehumidify.</p> <p>If NC is selected, D will be normally energized. D will de-energize to dehumidify.</p>	<p>Use the <b>+</b> or <b>-</b> key to turn on or off.</p>	<p>Use the <b>+</b> or <b>-</b> key to select the number of minutes to delay each stage.</p> <p>OFF 5, 10, 15, 30, 45 60, 90, delay minutes.</p>
Factory Default Settings		
NO	OFF	OFF

**Note:**  
Standard staging logic, optional satisfy setpoint and optional staging delay allows for job by job customization that balances comfort, energy efficiency and equipment longevity.



### Setting Target Humidity Setpoint

Follow the steps below to change your target humidity setpoint.

Press the **HUMIDITY** key

Use the **+** or **-** key to select the target humidity setpoint.

Press **DONE** when completed

**HUMIDITY KEY**



**TARGET HUMIDITY SETPOINT KEYS**



**Note:**

- The target humidity setpoint is not programmable. Unlike temperature, humidity does not change quickly and should not be programmed.
- Humidity is only energized during heat. Dehumidify is only energized during cool. Heat and Cool each have their own target setpoints.

### Ambient Humidity Display

Ambient humidity will flash opposite of the day and time, and HON if HEAT and FAN is energized at the same time. Ambient humidity will flash opposite of the day and time, and dON if COOL and FAN is energized at the same time.

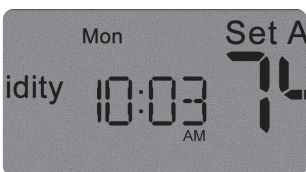

**DAY AND TIME**



**AMBIENT HUMIDITY**

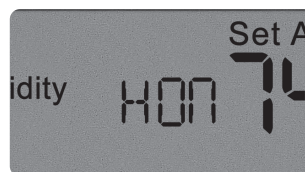

**HON (Humidify Energized)**

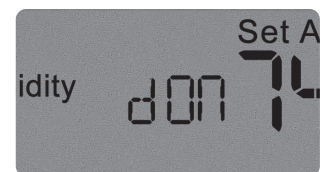

**dON (de-humidify Energized)**

### Recommended Heating Settings:

Increasing Humidity

The table on the right shows recommended indoor humidity levels in relation to outdoor temperatures during heating (adding humidity).

Outside Temperature (0°F)	Recommended Relative Humidity
+20° and above	35% to 40%
+10°	30%
0°	25%
-10°	20%
-20°	15%

### Recommended Cooling Settings:

Consult your professional HVAC technician for recommended settings for your climate.

# INSTALLATION MANUAL

## MOUNT THERMOSTAT & BATTERY INSTALLATION

### Mount Thermostat

Align the 4 tabs on the subbase with corresponding slots on the back of the thermostat, then push gently until the thermostat snaps in place.

**Note:** To insure a solid fit between the thermostat and the subbase:

1. mount subbase to flat wall
2. use screws & anchors provided
3. drywall anchors should be flush with the wall
4. wires should be pushed into the wall



### Battery Installation

Battery installation is optional if thermostat is hardwired (**C** terminal connected).

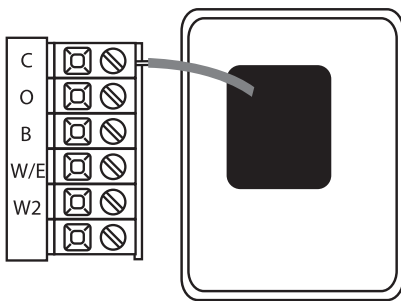

Insert 2 AA Alkaline batteries (included).

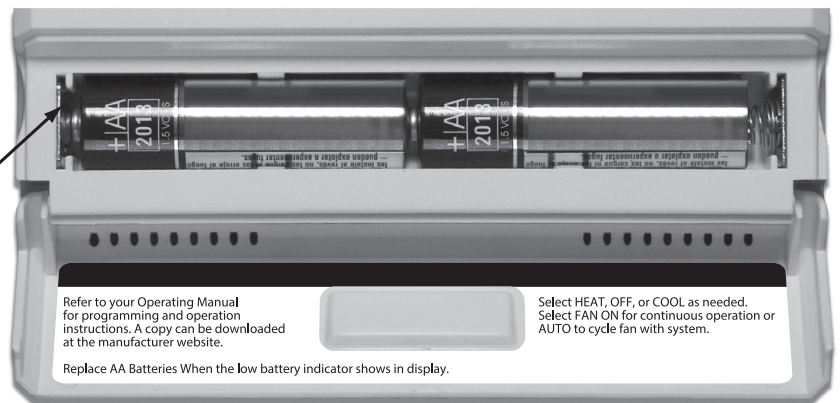

Simple operating instructions are found on the back of the battery door.

### Set Time













Follow the steps below to set the day of the week and current time:

1. Press **MENU**
2. Press **SET TIME**
3. Day of the week will be flashing. Use the **+** or **-** key to select the current day of the week.
4. Press **NEXT STEP**
5. The current hour is flashing. Use the **+** or **-** key to select the current hour. When using 12-hour time, make sure the correct a.m. or p.m. choice is selected.
6. Press **NEXT STEP**
7. Minutes are now flashing. Use the **+** or **-** key to select current minutes.
8. Press **DONE** when completed













### Programming

All our programmable thermostats are shipped with an energy saving pre-program. You can customize this default program by following the Set Program Schedule.

Your thermostat can be programmed to have all the weekdays the same, a separate program for Saturday, and a separate program for Sunday. There are four time periods for each program (**WAKE, LEAVE, RETURN, SLEEP**).

Factory Default Program				
Day of the Week	Events	Time	Setpoint Temperature (Heat)	Setpoint Temperature (Cool)
Weekday	Wake 	6 a.m.	70° F (21° C)	75° F (24° C)
	Leave 	8 a.m.	62° F (17° C)	83° F (28° C)
	Return 	6 p.m.	70° F (21° C)	75° F (24° C)
	Sleep 	10 p.m.	62° F (17° C)	78° F (26° C)
Saturday	Wake 	8 a.m.	70° F (21° C)	75° F (24° C)
	Leave 	10 a.m.	62° F (17° C)	83° F (28° C)
	Return 	6 p.m.	70° F (21° C)	75° F (24° C)
	Sleep 	11 p.m.	62° F (17° C)	78° F (26° C)
Sunday	Wake 	8 a.m.	70° F (21° C)	75° F (24° C)
	Leave 	10 a.m.	62° F (17° C)	83° F (28° C)
	Return 	6 p.m.	70° F (21° C)	75° F (24° C)
	Sleep 	11 p.m.	62° F (17° C)	78° F (26° C)

You can use the table below to plan your customized program schedule if using 5+1+1.

Programming Table				
Day of the Week	Events	Time	Setpoint Temperature (Heat)	Setpoint Temperature (Cool)
Weekday	Wake 			
	Leave 			
	Return 			
	Sleep 			
Saturday	Wake 			
	Leave 			
	Return 			
	Sleep 			
Sunday	Wake 			
	Leave 			
	Return 			
	Sleep 			

### Set Program Schedule

To customize your 5+1+1 program schedule, follow these steps

- Weekday:**
1. Select **HEAT** or **COOL** using the **SYSTEM** key.  
**Note:** You have to program heat and cool each separately.
  2. Press **MENU**.
  3. Press **SET SCHED**. **Note:** Monday-Friday is displayed and the **WAKE** icon is shown. You are now programming the **WAKE** time period for the weekday setting.
  4. Time is flashing. Use the  or  key to make your time selection for the weekday **WAKE** time period.  
**Note:** If you want the fan to run continuously during this time period, select **ON** with the **FAN** key.
  5. Press **NEXT STEP**.
  6. The setpoint temperature is flashing. Use the  or  key to make your setpoint selection for the weekday **WAKE** period.
  7. Press **NEXT STEP**.
  8. Repeat steps 4 through 7 for weekday **LEAVE** time period, for weekday **RETURN** time period, and for weekday **SLEEP** time period.

### Saturday:

9. Repeat steps 4 through 7 for Saturday **WAKE** time period, for Saturday **LEAVE** time period, for Saturday **RETURN** time period, and for Saturday **SLEEP** time period.

### Sunday:

10. Repeat steps 4 through 7 for Saturday **WAKE** time period, for Saturday **LEAVE** time period, for Saturday **RETURN** time period, and for Saturday **SLEEP** time period.

#### A Note About Programmable Fan:

The programmable fan feature will run the fan continuously during any time period it is programmed to be on. This is the best way to keep the air circulated and to eliminate hot & cold spots in your building.

## Specifications

---

The display range of temperature	.....	41°F to 95°F (5°C to 35°C)
The control range of temperature	.....	44°F to 90°F (7°C to 32°C)
Load rating	.....	1 amp per terminal, 1.5 amp maximum all terminals combined
Display accuracy	.....	± 1 °F
Swing (cycle rate or differential)	.....	Heating is adjustable from 0.2°F to 2.0°F Cooling is adjustable from 0.2°F to 2.0°F
Power source	.....	18 to 30 VAC, NEC Class II, 50/60 Hz for hardwire (common wire) Battery power from 2 AA Alkaline batteries
Operating ambient	.....	32°F to +105°F (0° to +41°C)
Operating humidity	.....	90% non-condensing maximum
Dimensions of thermostat	.....	4.7 "W x 4.4 "H x 1.1"D